



DanVex DEH-1600i DanVex DEH-1900i

Dehumidifiers

» Operation manual



Rev. 6.14



Operation instructions

Please read these instructions carefully before installing / operating this unit!
Our warranty becomes null and void in case of the unit improper operation, installation or maintenance or in case of the supplied unit modification without prior consent from our part.
Design is subject to changes!



Air dehumidification

The processes that take place during dehumidification are based on physical laws. We will try to illustrate them here in a simplified form to give you a general idea of dehumidification principles.

Attention!!! These units cannot be used for air cooling!!!



Use of DanVex dehumidifier

- Despite of windows and doors insulation quality, damp and moisture can penetrate even through thick concrete walls.
- It can take 1-2 months for the water used for construction (concrete works, whitewashing, plasterworks etc.) to dry out.
- The moisture that has penetrated masonry following high water or flooding is released very slowly.
- Damping of materials during storage in moist unheated premises.

The moisture escaping from building elements or materials by evaporation is absorbed by the ambient air. Thus, this increases the air humidity and ultimately results in corrosion, mould, rot, peeling of paint coatings and other unwanted damages.

The below diagram shows an example of metal corrosion rate at different air humidity levels.

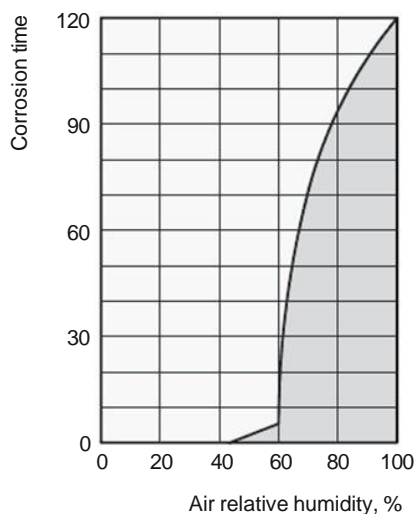

As you can see on the graph the rate of corrosion is insignificant at the relative humidity (RH) below 50%, and it can be disregarded at RH below 40%. But at the relative humidity above 60% the rate of corrosion increases considerably.

This moisture damage example applies also to many other materials, such as powders, packaging, wood, electric equipment or electronic devices.

There are two different ways of achieving required humidity in a building being dried out:

1. By heating with further air exchange:

The ambient air is heated to absorb the moisture and then it is discharged to the atmosphere. However the total energy output is lost during the moist air discharging to outside.

2. By the air dehumidification:

The moist air in an enclosed room is continuously dehumidified by the condensation principle or by other dehumidification method.

In terms of energy consumption the air dehumidification has one essential advantage:

the energy expenditure requirements are limited by the air volume in the existing room only.

The heat generated during the air dehumidification process (heat of condensation) slightly increases the air temperature in the room.

When properly used the dehumidifier consumes about 25% of the energy that would be needed for the „heating and ventilation“.

The relative and absolute air humidity

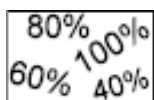

1 m³ of dry air weighs about 1,2 kg at 20° C.

The ambient air is a gas mixture that always contains a certain amount of water in the form of water vapor. The maximum water vapor content in the air (moisture content of the saturated air) depends on its temperature and pressure.

The *absolute humidity* is understood to be the water content in the dry air unit volume and is expressed in grams (g) of the water per a kilogram (kg) of the dry air.

The *relative humidity* is understood to be the ratio between the water percent currently contained in the dry air and the maximum possible water content at certain temperature and pressure and is expressed in percents (%).

When the air absorbs the maximum possible water volume the air becomes "saturated" and the relative humidity becomes 100%.

 The ability of air to absorb water vapor increases with temperature increasing. This ; that the maximum (absolute) water content increases with temperature increasing.

Temp. °C	Water vapor content in g/m ³ in the air at the humidity of			
	40%	60%	80%	100%
-5	1,3	1,9	2,6	3,3
+10	3,8	5,6	7,5	9,4
+15	5,1	7,7	10,2	12,8
+20	6,9	10,4	13,8	17,3
+25	9,2	13,8	18,4	23,0
+30	12,9	18,2	24,3	30,3

Water vapor condensation

The maximum water vapor volume that can be absorbed increases when the air is **heated**, but the water vapor content remains however the same and this results in relative humidity reduction.

In contrast, when the air is **cooled**, the maximum water vapor volume that can be absorbed continuously reduces, the water vapor volume contained in the air remains however the same and the relative humidity increases.

If the air temperature falling continues the capacity to absorb the water vapor volume is continuously reduced until the air becomes saturated which is equal to the maximum water vapor content in the air. This temperature is called the dew-point temperature.

When the air is cooled below the dew-point temperature, the water vapor content becomes higher than the maximum possible water vapor content.

Excess water vapor displacement starts. The vapor condenses to water and thus is removed from the air.

A misted window glass in winter or a misted bottle with a cold drink are common examples of condensing.



The higher the relative air humidity the higher is the dew-point temperature, and thus it is easier to fall below the dew-point temperature.

Drying materials

Building materials/structures can absorb considerable amounts of water, e.g. bricks can absorb 90-190 l/m³, heavy concrete can absorb 140-190 l/m³, sand-lime bricks can absorb 180-270 l/m³.

Wet materials such as masonry are dried as follows:

- The moisture contained in the material moves from within the material to the wall surface.
- Evaporation takes place on the surface, i.e. water vapor is absorbed by the ambient air.
- The air enriched with water vapor continuously circulates through the air dehumidifier. It is dehumidified and leaves the unit being slightly heated to absorb the moisture again.
- In this way, the moisture content in the material is continuously reduced and the material dries.

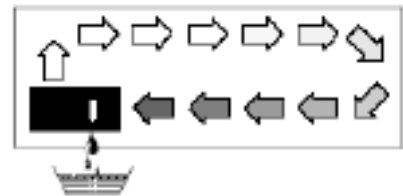
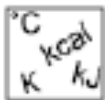
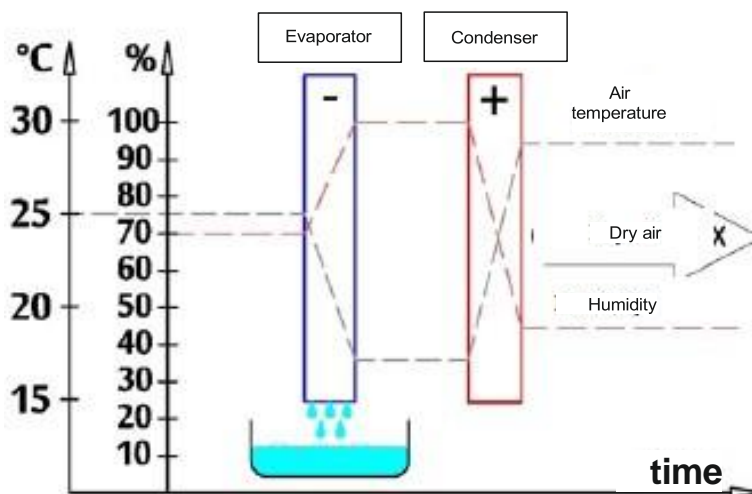

Diagram of the air condition during its circulation through the dehumidifier

The air flow is cooled on the way through the "evaporator-condenser" system till its temperature is below the dew point. Water vapor condenses, it is collected in a condensate trap inside the unit. The collected moisture is discharged in the form of water.



Heat of condensation

The energy transferred from the condenser to the air consists of:

- The heat earlier transferred from the evaporator.
- Useful electrical power
- The heat of condensation released through the condensation of water vapor.

When liquid turns into a gaseous state, the energy should flow in reverse i.e. from liquid to gas. This energy is called the **heat of evaporation**. It does not cause any rise of temperature, it is only necessary for the change from a liquid to a gaseous state. Vice versa, the energy is released when gas turns into liquid, such energy is called heat of condensation.

The heat generated at condensation and evaporation and is identical.

For water this is 2250kJ/kg (4.18kJ = 1kcal)

This shows that a relatively large amount of energy is released in the process of water vapor condensation.

If the moisture to be condensed is not generated at evaporation in the room but is introduced from outside, e.g. via ventilation, the heat of condensation released in the process will be used for the room heating.

If it is required to dry materials or rooms the heat energy circulates, i.e. it is consumed during evaporation and is released during condensation. A large amount of heat energy is generated at the supplied air dehumidification process, which results in a rise of temperature.

The time necessary for drying of building structures does not depend on the dehumidifying unit capacity, but is determined by the rate at which the material or the building elements release the moisture they contain.

Safety Instructions

Prior to delivery the units are subject to comprehensive testing of their materials, functional capabilities and quality.

However hazards can arise if the unit is operated by untrained persons unfamiliar with its operation principles or in case the unit is not used for the intended purpose.

The following safety instructions must be observed:

- It is prohibited to install or operate the units in the locations subject to explosion hazard.
- It is prohibited to install or operate the units in the locations with oil, sulphur, chlorine or salt containing atmospheres.
- The units must be installed upright.
- It is prohibited to use a direct jet of water for the unit washing.
- It is prohibited to cover the air inlet and outlet holes.
- The intake side of the unit must be free of dirt and loose objects.
- It is prohibited to insert objects in the unit.
- It is prohibited to cover or transport the unit during operation.
- All electric cables outside the unit must be protected against damage (e.g. from animals etc.).
- It is necessary to insure that all cables meet the requirements for capacity, length and purpose.
- The unit must only be transported in vertical condition. The condensate containers must be drained prior to each transportation of the unit.
- It is prohibited to use the unit for purposes other than intended or not specified in this operations instructions.

In case the requirements are not observed our company disclaims any liability and our warranty becomes null and void.



Only authorized personnel is permitted to perform works on cooling and critical system!

Unit description

The unit is designed for automated, versatile and trouble-free air dehumidification.

The unit operates on condensation principle. It is equipped with a closed loop cooling system, low noise and low maintenance fan and with a power cable with a plug.

The unit's control panel is equipped with a LCD display used for the system functional checks. A fully automated unit control system, a trouble-free regulated humidistat, an integrated overflow system as well as flexible hose connection for direct condensation discharge assure fail safe and long-term operation of the unit.

The unit complies with the fundamental safety and health requirements of the existing EU regulations.

The unit is easy and safe to operate.

Unit location

The unit is operated in the buildings where dry air is necessary to prevent significant financial losses (for example, due to mould formation).

The unit is mainly used for drying and dehumidification of:

◇ Industrial buildings of various applications, storage rooms and cellar rooms.

It is also used for dry air maintenance in:

◇ Storage areas, archives, laboratories.

◇ Laundries, changing rooms etc.

Functions

The unit operates on condensation principle.

The fan intakes moist surrounding air into the units rear side through the air filter, evaporator and condenser located behind the evaporator.

Heat is extracted at the cold evaporator. The air is cooled to below the dew point. The water vapor contained in the room air deposits as condensate or frost on the evaporator fins.

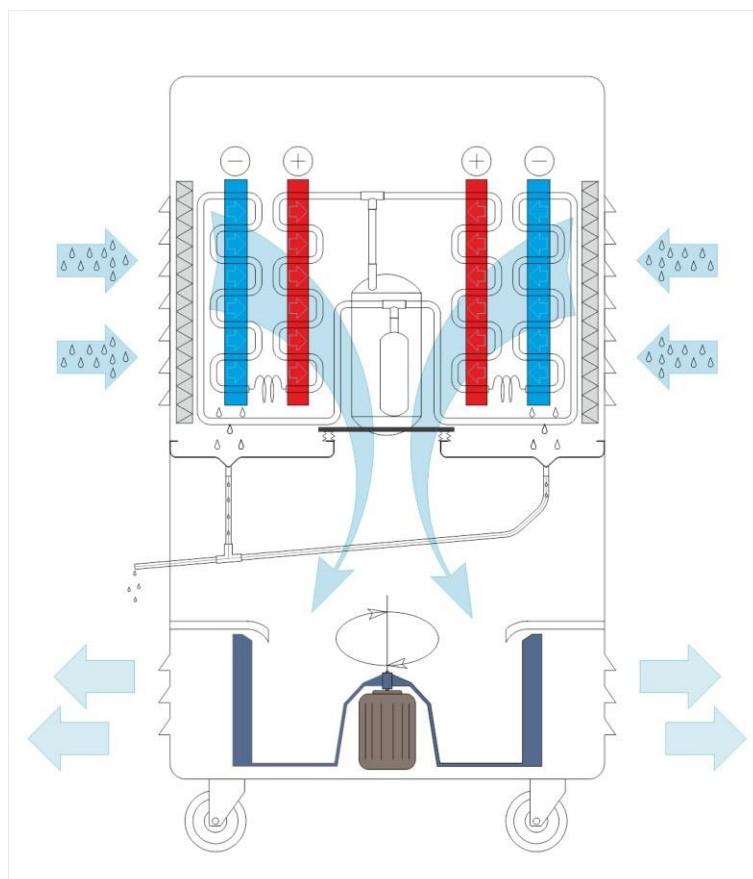

Dried and cooled air is heated in the condenser (radiator) again. Then it is discharged to outside, the air temperature is about 5 degrees higher than the room temperature. The dried air is mixed with surrounding air again. The relative humidity gradually drops to the required RH value due to continuous outside air circulation through the unit. Depending on the room temperature and relative humidity the condensed water can drip continuously or only during certain defrosting stages into a condensate tray with further discharge to outside through integrated drain channels. For uncontrolled continuous operation of the unit it is required to drain the condensate using an external water hose.

Installation

For optimum, economical and safe unit operation the following instructions must be followed:

- ◇ The unit must be installed securely upright to ensure unhindered condensate discharge into the condensate tray.
- ◇ If possible the unit must be installed in the centre of the room long wall so that optimal air circulation is ensured.
- ◇ It must be ensured that the air is able to be sucked in freely at the front of the unit and to be discharged through the side parts of the air throttle.
- ◇ It is prohibited to locate the unit in close proximity to radiators and other heat sources.
- ◇ The room to be dried or dehumidified must be closed to prevent the air entering from neighbor rooms and from outside.
- ◇ Windows and doors must be closed to prevent free air exchange between the room and ambient atmosphere.
- ◇ If the unit is used in dust-laden environments it is necessary to take appropriate maintenance measures specially adapted to the particular operation conditions.
See the chapter «Maintenance and service».

Important information on electrical connections

- ◇ Electric wiring of the unit should be done in accordance with DIN VDE 0100, Part 704 for electric current supply sources equipped with automatic circuit-breakers.
- ◇ If the unit is installed in humid premises such as laundries or cellars it should be equipped with proper automatic circuit-breakers at the buyer's expense.

Commissioning

Prior to commissioning works or to comply with local requirements it is necessary to check air intake openings and outlet openings to be sure that they are free from foreign matters. Intake filters condition should be checked as well.

The following instructions are to be observed:

- ◇ Extension cables should be of proper cross-section.
- ◇ It is allowed to use extension cables if they are fully disentangled or stretched!
- ◇ It is not allowed to pull the unit by the power cord.
- ◇ Upon actuation the unit operates in fully-automatic mode.
- ◇ The unit is equipped with a protection device that prevents the compressor from switching on at restart immediately after the unit switching off, thus preventing the compressor damage.

The compressor switches on after 3 minutes only.

We do not ensure the efficient operation of the unit if the room temperature is below 10 °C and if the relative humidity is below 40 %.

Explode drawing:

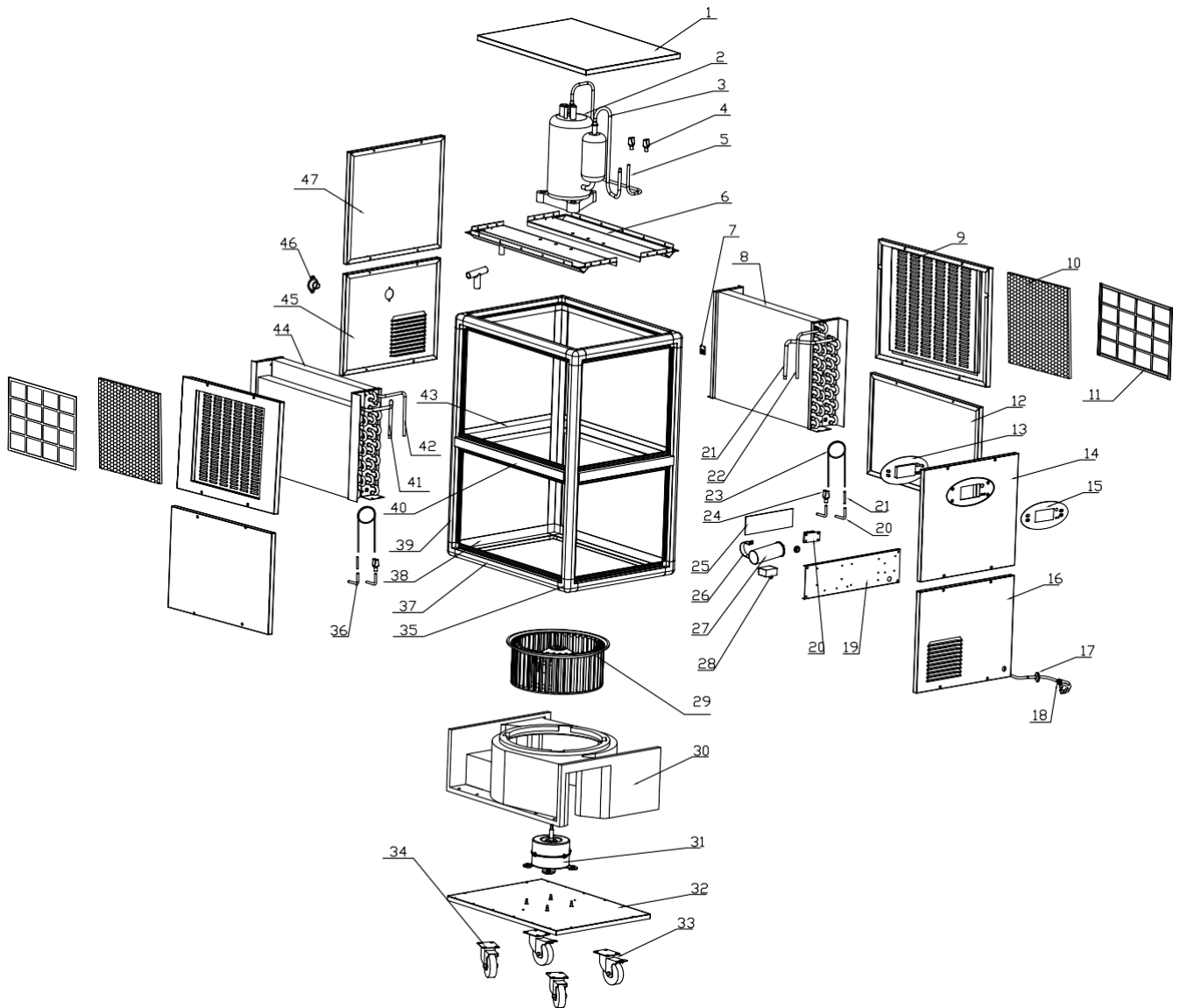

Control panel and LCD-display

Dehumidifier control elements are located on the dehumidifier body on the left side upper panel.

LCD display

Button ON/OFF

Button TIMER

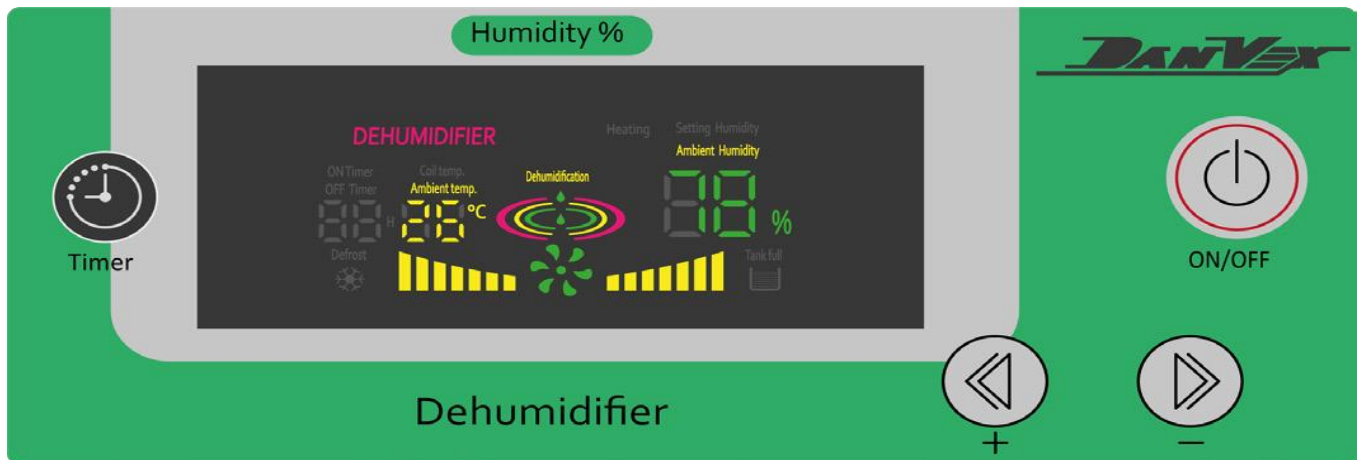

Button HUMIDITY UP

Button HUMIDITY DOWN

Button Function

1. "Power" / "ON/OFF button

Press this button to start the machine, it enters start-up mode after the buzzer buzzes twice. Press this button to stop the machine, it enters stop mode after the buzzer buzzes once.

2.1 "Timer" button (for 2G controller)

A, In standby mode, press "timer" to set Auto starting time, "on time" will flash in screen, and click "+" or "-" to adjust the time; **B**, In working mode, press "timer" to set Auto stop time, "off time" will flash in screen, and click "+" or "-" to adjust the time;

3. "+" button

Press this button directly to increase the set humidity. Buzzer buzzes once for each pressing and the set humidity increases by 1% RH. Successive operation can be achieved by pressing this button successively. Press "Time" button before pressing this button, the time (hour) can be increased.

4. "-" button

Press this button directly to decrease the set humidity. Buzzer buzzes once for each pressing and the set humidity decreases by 1% RH. Successive operation can be achieved by pressing this button successively. Press "Time" button before pressing this button, the time (minute) can be decreased.

We do not ensure the efficient operation of the unit if the room temperature is below 10 °C and if the relative humidity is below 40 %.

Operating the machine

1. Energize the power, the dehumidifier will beep for once;
2. Press the "On/Off" button for once, the LCD display is light. After all the displays are normal, the LCD displays current environment humidity;
3. Setting of humidity: press "+" and "-" buttons to set the required humidity. When the set humidity is 3% less than current humidity, the dehumidifier works; when the set humidity is 3% more than current humidity, the dehumidifier stops.
4. When the set humidity is less than 30%, the dehumidifier enters the mode of successive dehumidification.
5. Setting of preset time:
Press the "Time" button for the first time, the "hour" time on the display flashes , press "+" and "-" to adjust the current hour and minute time; Press the "Time" button for the second time, the "Start-up time" on the LCD flashes, press "+" and "-" to adjust the current hour and minute time; Press the "Time" button for the third time , the "Stop time" on the LCD flashes , Press "+" and "-" to adjust the current hour and time; Press the "Time" button for the forth time, the mode of "preset time "can be canceled.
6. After setting the mode of preset time, if the dehumidifier is shut off, it will operate the whole mode of preset time; if it is in operation, it will operate the mode of "preset stop time".

Operation Notices

1. When moving the machine, do not incline the machine for over 45° to avoid damaging the compressor.
2. Temperature for operation of this machine is 5-35°C.
3. When it is operating, the compressor gives off heat when it works, and ambient temperature may rise by 1-3°C. Such phenomenon is normal and is safe to use.
4. When ambient temperature is below 10°C and absolute humidity is relatively low, there is no need to use dehumidifier.
5. The air inlet and outlet must be away from the wall for at least 10cm in order not to impair the dehumidification effect.
6. Working environment shall be as airproof as possible to maximize dehumidification on effect.
7. Dust on the air purification filter mesh may impair its effect or even cause failure. Please clear regularly for at least once a month. If there is much dust in the environment it must be cleared once a week or once a day. Pull down the front panel clear the filter mesh. Tap the filter mesh slightly or eliminate the dust by vacuum cleaner or place the mesh in warm water (≤40°C and add appropriate neutral scour and brush and then wash with clear water and dry it. Direct sunlight or baking shall be avoided to prevent deformation.



We do not ensure the efficient operation of the unit if the room temperature is below 10 °C and if the relative humidity is below 40 %.

Notices:

1. If the set humidity is higher than the actual humidity, the dehumidifier stops working;
2. During dehumidification, after the compressor starts working, the fan and compressor can only be stopped after working for at least 3 minutes; the compressor can only be re-started 3 minutes after stops;
3. If works under low temperature, the dehumidifier may judge the system temperature automatically and defrosts automatically; when defrosting, the indicator of defrosting is light, the fan works and compressor stops working.
4. The system has auto memory. When all the mode setting has been finished, if there is sudden power cut during operation, or the power jack slips out, the system may store the current status before the power is cut and enter the operation mode before power cut automatically after power is supplied;
5. Range for humidity is 20% -90%;
6. If the dehumidifier is going to be spared for a long time, please unload the power cord or cut the power.
7. Auto detection of temperature /humidity failure.
 - a. When the system detects that temperature sensor exceeds the limited range, the system enters mode of temperature sensor failure. Under this mode, LCD displays temperature failure code"E1",the system works in circle of dehumidification for 30 minutes and defrosting for 15 minutes;
 - b. When the system detects that humidity sensor exceeds the limited range, the system enters mode of humidity sensor failure. Under this mode, LCD displays humidity failure code"E2"and the system enters continuous dehumidification.
 - c. After temperature /humidity sensor failure is limited, the system works normally.

Operation Safety and Maintenance

Do not connect relay, extension cord or adaptor with this machine. Otherwise, fire, electric shock and heating can be caused.

Do not place it near to equipment's give heat such as furnace and heater. Otherwise, the resin may be melted and causes fire.

Do not use this dehumidifier in places with direct sunlight or exposed to wind and rain. This machine is for indoor use only. When there is any abnormality (smell of burnt), please shut off the machine and unload the power cord. Otherwise, fire, electric shock and new failures may be caused.

Do not use this dehumidifier in places exposed to chemicals. The chemicals and solvent in the air may bring adverse effect to the machine and result in leakage in water tank. If the machine is spared for a long time, please unload the power cord. When clearing the machine, stop it first and unload the power cord. Otherwise, human injury may be caused. During continuous drainage, please place the drain pipe appropriately for smooth drainage. If there is any possibility that temperature around pipe may result in icing, continuous water drain is not allowed.

Do not repair, disassemble or alternate the machine without authorization so as to avoid fire or electric shock accidents; Please place the machine in firm places;

If the machine falls down, the water in water tank may leak out and damages stuff around and results in creepage and cause fire or electric shock accidents;

Knacks to extend the service life of air purification filter mesh: If to be spared for a long time, keep the air purification filter mesh in plastic bag and save hermetically.

Do not use dehumidifier in places that may be exposed to water.

There may be creepage if there is water and result in fire or electric shock. Please use proper switch. Otherwise, fire or electric shock accidents may be caused.

Do not damage or alternate the power cord.

Do not place heavy things on power cord or heat up or pull forcefully the power cord, otherwise power cord may be damaged and causes fire or electric shock accidents. Please connect the power cord firmly with the switch. If the power cord is loose, there may be risk of electric shock.

Do not stop operation of dehumidifier by pulling out the power cord. Otherwise fire or electric shock accident may be caused.

Common Troubleshooting

Failure	Cause analysis	Method
Dehumidifier cannot work	<ol style="list-style-type: none"> 1. Power cut 2. Power switch is not energized 3. Power cord is not connected 4. Fuse is melted 	<ol style="list-style-type: none"> 1. Recover the power 2. Energize the power 3. Connect the power cord 4. Replace the fuse
Dehumidification is not ideal	<ol style="list-style-type: none"> 1. Dust accumulated in air purification filter mesh 2. Object blocking air inlet and outlet 3. The door or window is open 4. Refrigerant is leaking 	<ol style="list-style-type: none"> 1. Clear the filter mesh 2. Remove the blocking object 3. Close the door and window 4. Contact with distributor or manufacturer for repair
Water leak	<ol style="list-style-type: none"> 1. The machine is inclined 2. Water pipe is blocked 	<ol style="list-style-type: none"> 1. Level the machine 2. Remove the blocking object
Abnormal noise	<ol style="list-style-type: none"> 1. The machine is not placed solidly 2. The filter mesh is blocked 	<ol style="list-style-type: none"> 1. Place the machine firmly. 2. Clear the filter mesh.

1. Where the above troubles cannot be fixed and repair is needed, please contact supplier or distributor. Do not disassemble without authorization.
2. When the dehumidifier is in operation or stops, voice of circulating of refrigerating can be heard. Such phenomenon is normal.
3. It is normal for the air outlet to drain hot air.

Instruction on Code of Failure

This dehumidifier is able to automatically judge failure. If there is any failure, there will be failure code displayed on the humidity display window.

Controller error codes

Failure Display	Problem
E1	Temperature sensor failure
E2	Humidity sensor failure
E3	Phase sequence failure (for 380V power supply devices only)
E4	Water tank full (for the devices equipped water tank only)
E5	High temp./pressure
E6	Low pressure alarm (leakage may happen inside)

Performance charts

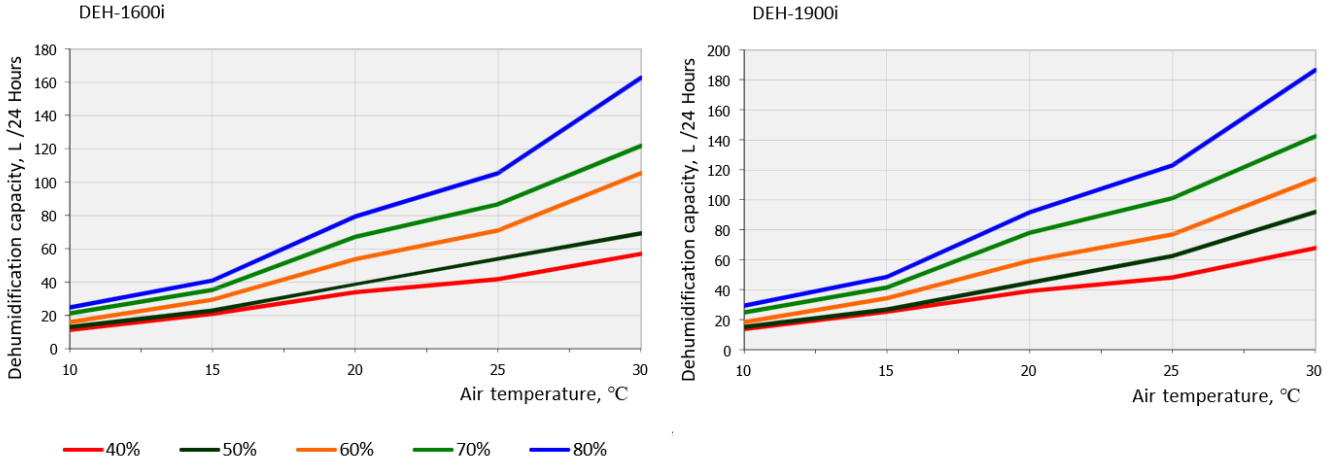

Dimensions

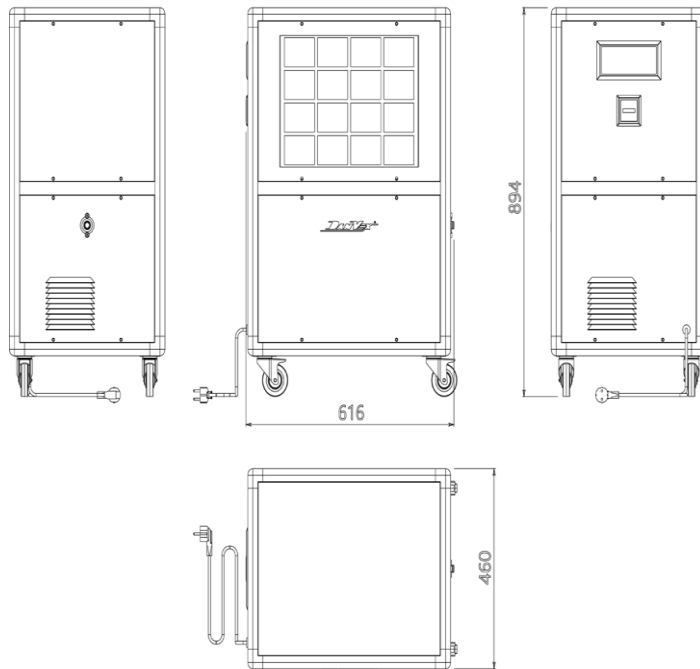

Attachment. Electrical diagram

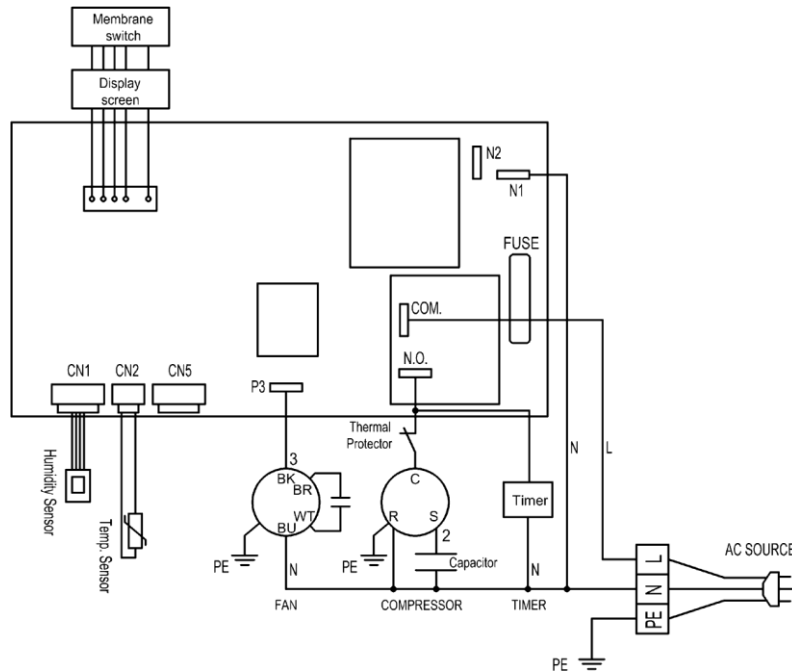

Specifications

Model		DEH-1600i	DEH-1900i
Operational temperature range	°C	10-35	10-35
Operational humidity range	% RH	30-100	30-100
Dehumidification (at 30 °C / 80% RH)	l/day	160	190
Air capacity	m3/hour	1150	1250
Internal condensate tank capacity	liters	x	x
Cooling agent	-	R32, 1000g	R32, 1000g
Power	V	~230	~230
Frequency	Hz	50	50
Rated consumption	kW	1,8	2,13
Sound pressure	dB (A)	64	64
Depth	mm	460	460
Width	mm	600	600
Height	mm	900	900
Gross weight	kg	70	75

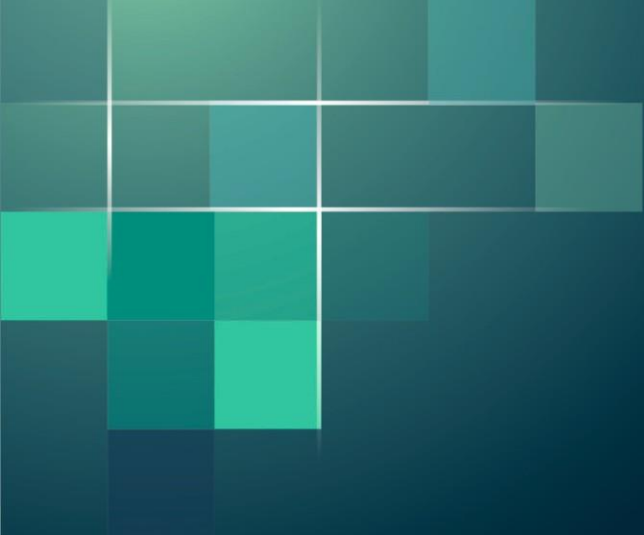

DANVEX[®]

WWW.DANVEX.COM

