



# Dehumidifiers

## DEH-1200p / DEH-1700p

» Operation manual





rev. 6.14

## Content

WARNING OF R32.....	3
Safety Instruction.....	5
Attention during Usage.....	6
Principle of dehumidifier.....	8
Specification.....	8
Exploded Views.....	9
Installation note.....	11
Descriptions of Parts.....	11
Panel Control.....	12
Operation Guide.....	13
AUTO Operation Mode.....	14
Air Direction Adjustment.....	15
Timer Operations.....	16
Defrost system.....	17
Water drainage system.....	17
Wiring diagram.....	18
Maintenance.....	19
Error Codes.....	21
Trouble shooting.....	21

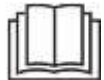
## WARNING OF R32

	<p>WARNING (Risk of fire)</p>	<p>This mark is for R32 refrigerant only. Refrigerant type is written on nameplate. In case that refrigerant type is R32, this unit uses a flammable refrigerant. If refrigerant leaks and comes in contact with fire or heating part, it will create harmful gas and there is risk of fire.</p>
	<p>Read the MANUAL carefully before operation.</p>	
	<p>Service personnel are required to carefully read the MANUAL before operation.</p>	
	<p>Further information is available in the MANUAL.</p>	

### 1. **Work procedure**

The work must be carried out according to a controlled procedure, in order to minimize the risk of presence of flammable gases or vapors during the execution of the works.

### 2. **General work area**

All persons in the area must be informed of the nature of the work in progress. Avoid working in a confined area. The area around the work area should be divided, secured and special attention should be paid to nearby sources of flame or heat.

### 3. **Verification of the presence of refrigerant**

The area should be checked with a suitable refrigerant detector before and during work to ensure that there is no potentially flammable gas. Make sure that the leak detection equipment used is suitable for flammable refrigerants, ie it does not produce sparks, is properly sealed or has internal safety.

### 4. **Presence of fire extinguisher**

If hot work is to be performed on the refrigeration equipment or any associated part, appropriate fire extinguishing equipment must be available. Install a dry powder or CO<sub>2</sub> fire extinguisher near the work area.

### 5. **No source of flame, heat or spark**

It is totally forbidden to use a source of heat, flame or spark in the direct vicinity of one or more parts or pipes containing or having contained a flammable refrigerant. All sources of ignition, including smoking, must be sufficiently far from the place of installation, repair, removal and disposal, during which time a flammable refrigerant may be released into the surrounding area. Before starting work, the environment of the equipment should be checked to ensure that there is no risk of flammability. «No smoking» signs must be posted.

### 6. **Ventilated area**

Make sure the area is in the open air or is properly ventilated before working on the system or performing hot work. Some ventilation must be maintained during the duration of the work.

### 7. **Controls of refrigeration equipment**

When electrical components are replaced, they must be suitable for the intended purpose and the appropriate specifications. Only the parts of the manufacturer can be used. If in doubt, consult the technical service of the manufacturer.

The following controls should be applied to installations using flammable refrigerants:

- The size of the load is in accordance with the size of the room in which the rooms containing the refrigerant are installed;
- Ventilation and air vents work properly and are not obstructed;
- If an indirect refrigeration circuit is used, the secondary circuit must also be checked.
- The marking on the equipment remains visible and legible. Illegible marks and signs must be corrected;
- Refrigeration pipes or components are installed in a position where they are unlikely to be exposed to a substance that could corrode components containing refrigerant.

#### **8. Verification of electrical appliances**

Repair and maintenance of electrical components must include initial safety checks and component inspection procedures. If there is a defect that could compromise safety, no power supply should be connected to the circuit until the problem is resolved.

Initial security checks must include:

- That the capacitors are discharged: this must be done in a safe way to avoid the possibility of sparks;
- No electrical components or wiring are exposed during loading, recovery or purging of the refrigerant gas system;
- There is continuity of grounding

## Safety Instruction

- Please read the following Safety Instructions carefully prior to use.
- The instructions are classified into two levels, WARNING and CAUTION according to the seriousness of possible risks and damages as follows. Compliance to the instructions are strictly required for safety use.

## Installation

### WARNING

Please call Sales/Service Shop for the Installation.

Do not attempt to install the air conditioner by yourself because improper works may cause electric shock, fire, water leakage.

Installation in a inadequate place may cause accidents. Do not install in the following place.

### CAUTION

Connect the earth cable.

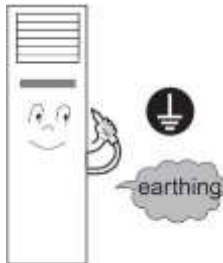

Do not install in the place where there is any possibility of inflammable gas leakage around the unit.



PROHIBITION

Do not expose the unit to vapors of chlorine, salt, acids, or oil vapors.



PROHIBITION

### WARNING

When abnormality such as burnt-smell found, immediately stop the operation button and contact sales shop.



OFF







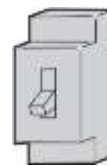

 STRICT ENFORCEMENT

Use an exclusive power source with a circuit breaker.

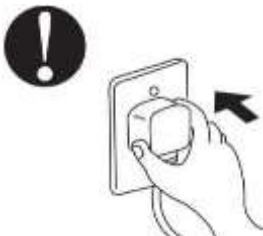



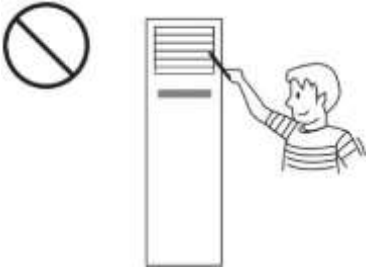

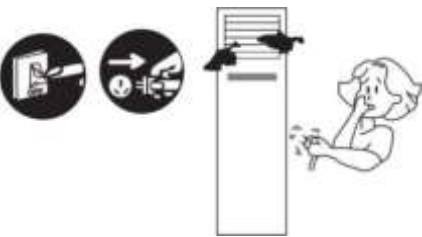
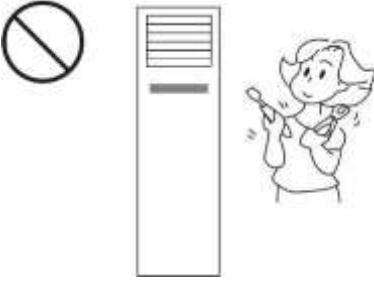
**Attention during Usage**

**! WARNING**

<p><b>Ensure the power plug is secure</b> If the plug is not secure, it may cause a electric shock, overheating or a fire.</p> 	<p><b>Never pull out the power plug during operation.</b> otherwise, it may cause a electric shock or a fire due to overheating.</p> 	<p><b>Never use damaged electric wires or unspecified electric wires.</b> otherwise it may cause a electric shock or a fire.</p> 
<p><b>Do not use the same socket with other electric appliances or use an extension cord.</b> otherwise it may cause a electric shock or a fire due to overheating.</p> 	<p><b>Do not operate when the hands are wet.</b> due to danger of a electric shock.</p> 	<p><b>Do not insert a rod or other objects into the inlet or outlet vents.</b> otherwise, it may cause a electric shock or a fire.</p> 
<p><b>Do not expose yourself to a single directional airflow for a long period</b>to avoid harming to your health.</p> 	<p><b>In case of abnormal condition (burning smell etc.),pull out the power plug to stop the dehumidifier from running, or disconnect the power supply by means of a electric current protector.</b> If the abnormal condition persists, it may cause a electric shock or a fire due to overheating. Please consult the dealer of service centre as soon as possible to arrange for a repair.</p> 	<p><b>Do not attempt to carry out a repair.</b> Improper repairs may cause a electric shock or a fire. You should contact the dealer of service centre to arrange for a repair.</p> 

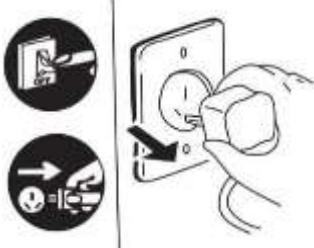
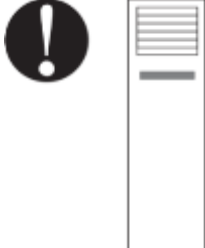
**Attention during Usage**

**! WARNING**

<p><b>Do not hold the electric wire to pull out the power plug.</b></p> <p>Pulling of the electric wire may cause overheating of the electric wire of a fire.</p> 	<p><b>If the dehumidifier is not in use for a long time, it is necessary to pull out the power plug.</b></p> <p>Excessive dust on the power plug may also cause overheating or a fire</p> 	<p><b>Switch off the power supply while cleaning the dehumidifier.</b></p> <p>Please take care not to damage the internal fan which is rotating at a high speed.</p> 
<p><b>Do not use the dehumidifier for other purposes.</b></p> <p>Do not use it for keeping precision instruments, food, plants and artistic items. This may affect the quality of the food.</p> 	<p><b>Do not place a heater in front of the dehumidifier.</b></p> <p>If internal combustion of the heater is not complete, it may give out poisonous carbon monoxide.</p> 	<p><b>Do not pour water onto the dehumidifier for cleaning.</b></p> <p>Due to danger of electric shocks.</p> 
<p>The dehumidifier is not intended for use in highly dusty or corrosive environments containing chlorine vapors, acids, solvents, oil mist, salt, etc.</p> <p>When using the unit in a swimming pool, it is necessary to control the water composition when adding chemicals. Primarily the formation of chlorine-containing vapors, adversely affects humans, can irritate the eyes and cause breathing difficult, they are also capable of disabling the equipment operating in the pool. The components of the dehumidifier must be protected against corrosion, otherwise its service life will be shortened.</p>		

## Principle of dehumidifier

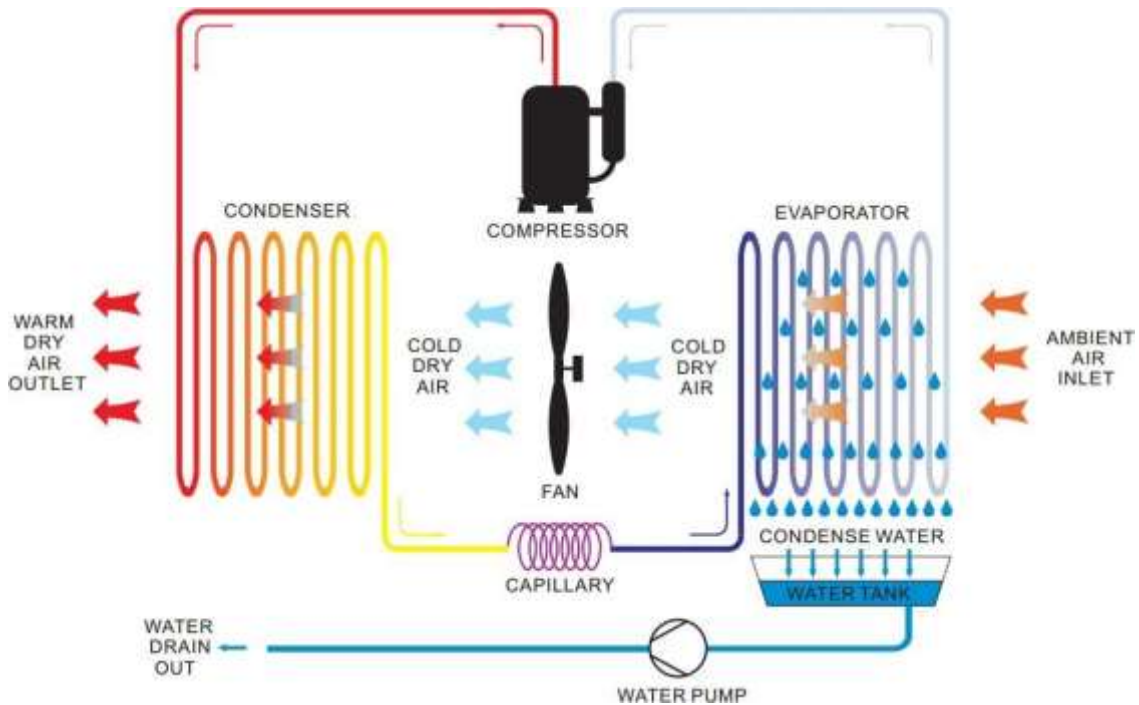

The dehumidifier uses the refrigeration circuit to change the damp air from warm to dry air. When the damp air passes the condenser, the air's water will be condensed, and the air will become dry.

## Specification

Model		DEH-1200P	DEH-1700P
Power supply	V/Ph/Hz	220-240~/1/50	220-240~/1/50
Dehumidify Capacity	L/Day	108	168
Applicable area	m <sup>3</sup>	100-150	150-200
Power	W	1300	1628
Current	A	5.8	7.4
Effective temperature range	°C	+10 .. +32	+10 .. +32
Effective humidity range	%	40-95	40-95
Refrigerant (R32)	g	630	700
Air flow	m <sup>3</sup> /hr	850	1000
Water pump		No	Yes
Drain pipe	mm	200	200
Noise	(dB(A))	47	48
Unit dimension	WxHxD(mm)	485x1735x310	485x1735x410
Packing dimension	WxHxD(mm)	565x1930x370	565x1930x470
Weight(net/gross)	kg	49/64	67/80

Test condition: Ambient temp.(DB) 30°C, Relative humidity of 80RH%.

Design and tech. specification are subject to change without prior notification.



# Exploded Views

## DEH-1200P

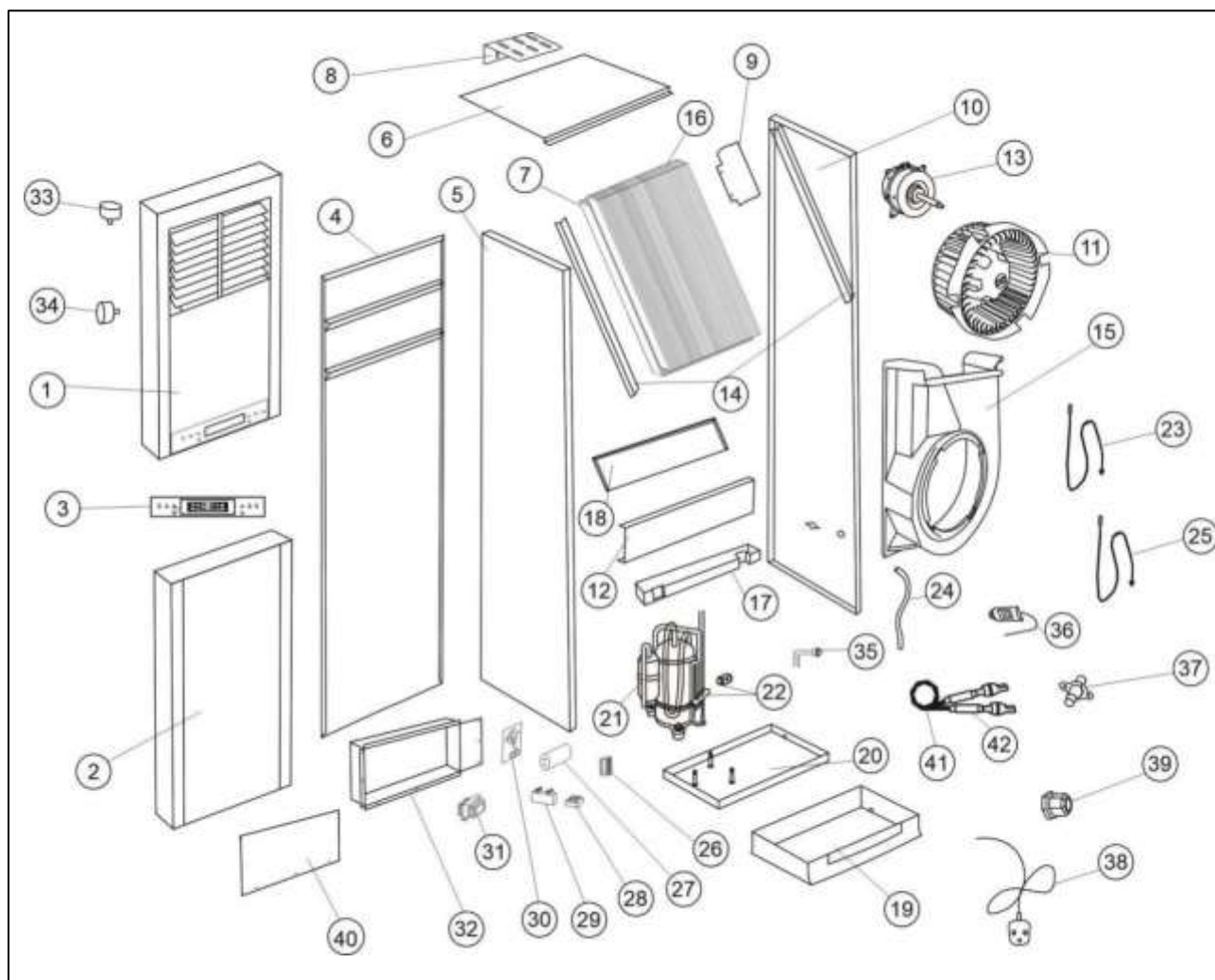

1	Front Panel 1	15	Plastic foam air duct	29	Motor Capacitor
2	Front Panel 2	16	Evaporator	30	Circuit Board
3	Control panel	17	Water pan	31	Transformer
4	Back panel (up)	18	Water fender	32	Electrical box
5	Left panel	19	Plastic-base	33	Stepper motor
6	Top cover	20	Chassis	34	Synchronous motor
7	Condenser	21	Compressor	35	Filling gas valve
8	Upper fixing board	22	Four Way Valve	36	Humidity sensor
9	Back panel (down)	23	Defrost sensor	37	Draining connector
10	Right panel	24	Drain pipe	38	Power Cord
11	Cross flow fan	25	Indoor temperature sensor	39	PG connector
12	Cover	26	Terminal	40	Electrical box cover
13	Fan motor	27	Compressor Capacitor	41	Capillary
14	Wind deflector	28	Public Terminal	42	Filter

Please note: The picture for reference only!

**DEH-1700P**

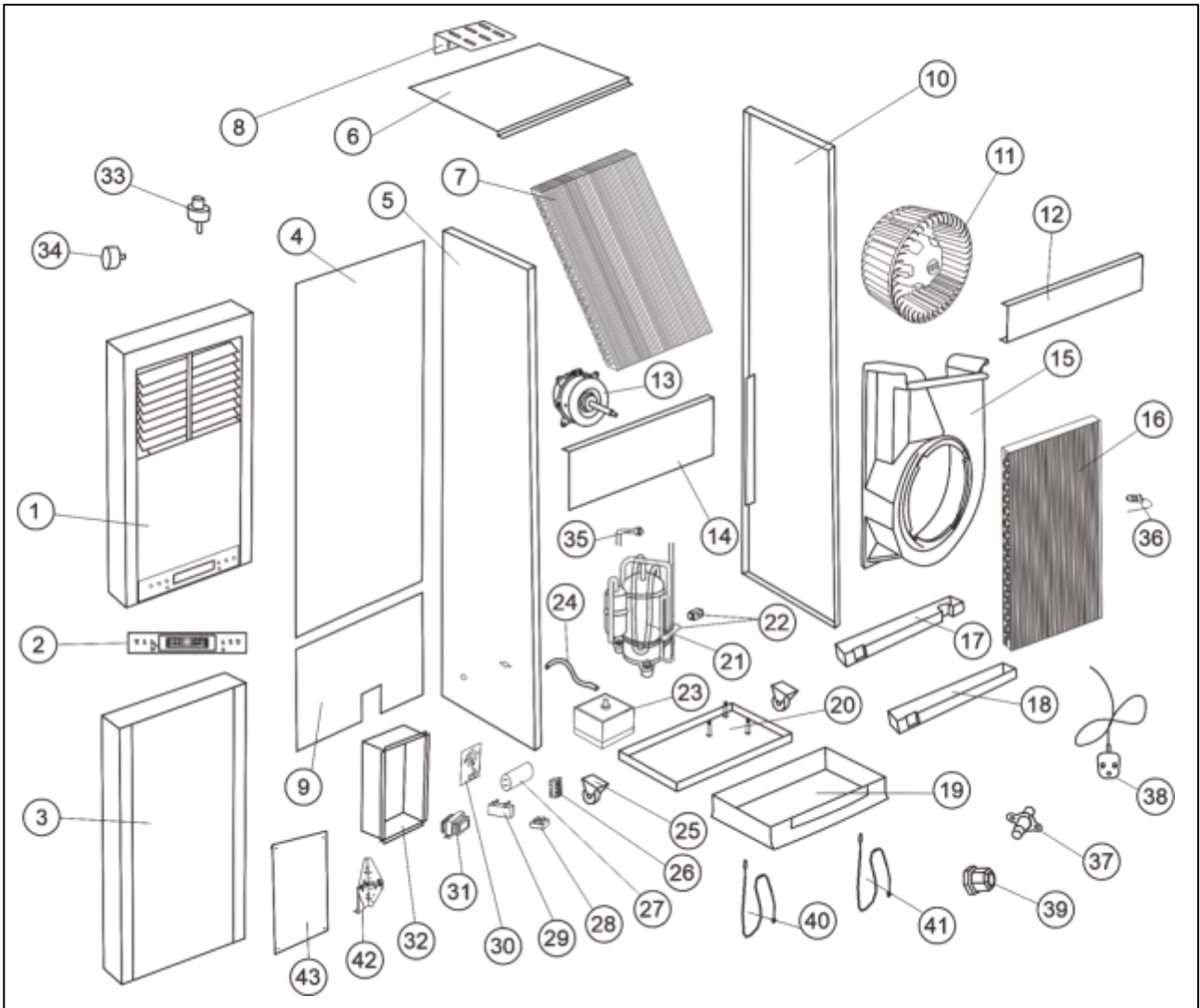

1	Front Panel 1	16	Evaporator	31	Transformer
2	Front Panel 2	17	Water pan	32	Electrical box
3	Control panel	18	Water fender	33	Stepper motor
4	Back panel (up)	19	Plastic-base	34	Synchronous motor
5	Left panel	20	Chassis	35	Filling gas valve
6	Top cover	21	Compressor	36	Humidity sensor
7	Condenser	22	Four Way Valve	37	Draining connector
8	Upper fixing board	23	Auto water drainage system	38	Power Cord
9	Back panel (down)	24	Drain pipe	39	PG connector
10	Right panel	25	Wheel	40	Defrost sensor
11	Cross flow fan	26	Terminal	41	Indoor temperature sensor
12	Cover	27	Compressor Capacitor	42	Support foot
13	Fan motor	28	Public Terminal	43	Electrical box cover
14	Wind deflector	29	Motor Capacitor		
15	Plastic foam air duct	30	Circuit Board		

Please note: The picture for reference only

## Installation note

To ensure dehumidifier is steady during running, it prepared top dead plate, the installation and use as following.

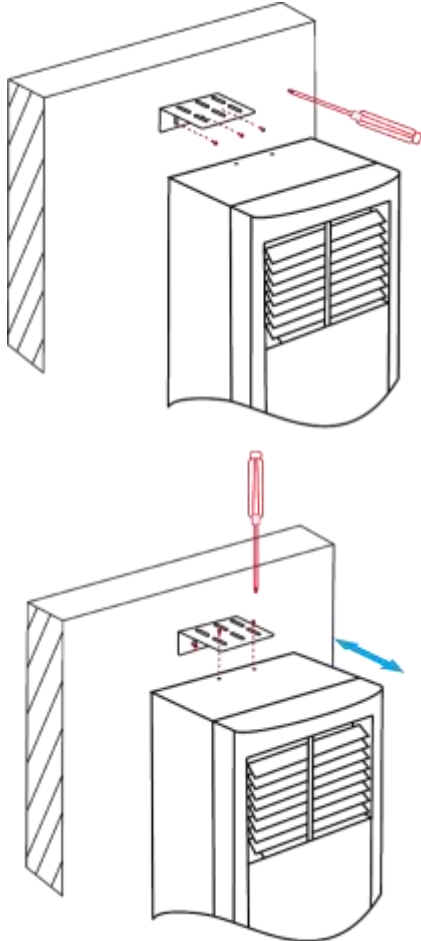

Please note the root support foot can draw out or draw back, it is convenient for user moving dehumidifier to other place by root wheel. (only for DEH-1700P)

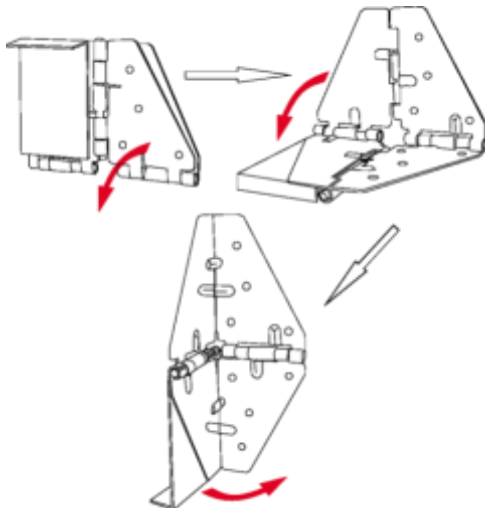

## Descriptions of Parts

- ① Air Outlet
- ② Control Panel
- ③ Air filter(inside)
- ④ Air Inlet
- ⑤ Drain pipe outlet (1200p)
- ⑥ Drain pipe outlet (1700p)

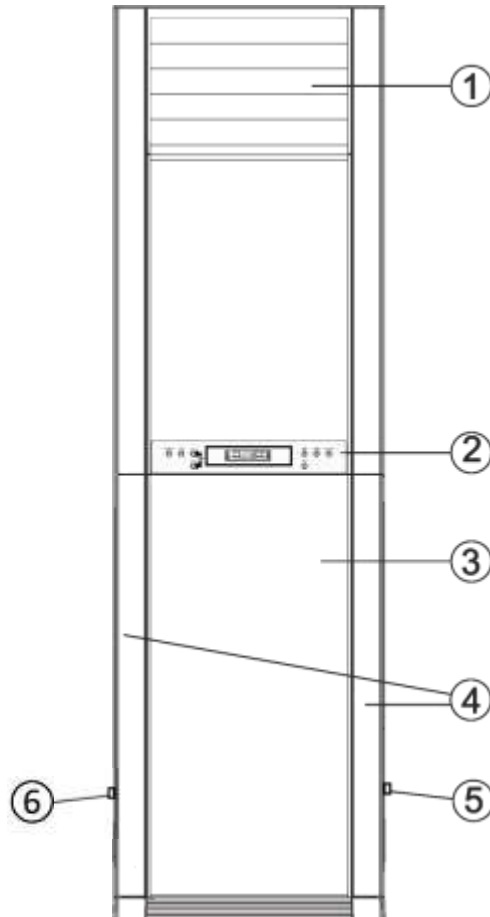

## Function of the needle valve

When the heat pump need to measure the pressure of the current system or to filling refrigerant, the operator can use this service valve and make the appropriate maintenance work!

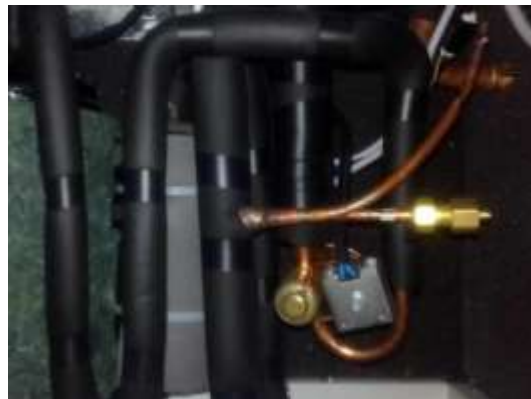

## Panel Control

### Button



- ON / OFF** Press the button to start operation, press the button again to stop operation.
- FAN SPEED** Select the fan speed. Fan speed is selected in a sequence: LOW , MID , HIGH.
- L - R** Set the swing or stop of Left-Right Airflow louver
- TIMER** Press the "L-R Swing" and "U-D Swing" together to enter timer setting.
- MODE** Mode is selected in a sequence: Automatic ; Dehumidifying ; Fan ; Heating.
- + / -** One press of the " + " button to raise the temperature by 1°C One press of the " - " button to lower the temperature by 1°C.
- U - D** Set the swing or stop of Up-Down Airflow louver.

### Display

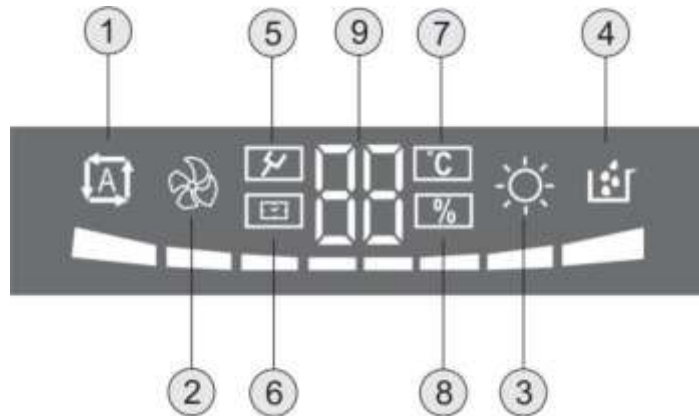

- ① Automatic temperature control (option)
- ② Fan operation mode
- ③ Heating operation mode (option)
- ④ Dehumidifying operation mode
- ⑤ Auxiliary electrical heater
- ⑥ Displays when turns to CLOCK status
- ⑦ Displays when turns to TEMPERATURE status
- ⑧ Displays when turns to HUMIDITY status
- ⑨ CLOCK or TEMPERATURE or display

## Operation Guide

### Proper settings of Heating, Dehumidifying and Fan modes

#### Mode Selection ( 1 )

Press "Mode" button to select the required working mode, which is changed in the following sequence when press once:



#### NOTE:

- Automatic operation will be explained in detail on next page.

#### Air Flow Selection ( 2 )

Press "FAN" button to select the required fan speed, which is changed in the following sequence when press once:

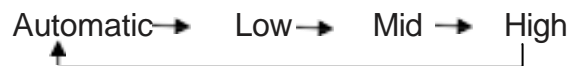

#### NOTE:

- When automatic FAN is selected, the dehumidifier will automatically select the suitable amount of air flow according to room temperature.
- When dehumidifying is selected, the amount of air flow is set by the machine and fan setting is not functional.

#### Temperature Setting Selection ( 3 ) ONLY WITH HEATER VERSION

Press Temperature Adjustment Button + to set temperature 1 degree higher.  
Press Temperature Adjustment Button - to set temperature 1 degree lower.  
Hold down the Button to increase or decrease the temperature settings progressively.

#### NOTE:

- Range of adjustable temperature settings : 18°C ~ 31°C.

#### Starting Operation ( 4 )

Press "On/Off" button, and when the unit receives the signal, it gives out two "beep" tones, the operation light is on and the dehumidifier starts operation.

#### NOTE:

- If it is desired to run the machine at the same settings for mode, air flow and temperature as the last operation, skip Steps 1~3 and start the machine directly. If the interval is shorter than 3 minutes from last shut down to the present switch-on, the compressor only re-starts after 3 minutes to protect the system. After switching on and if the mode is changed, the system may delay for 3 minutes before starting operation.

When heating mode is selected, the internal fan will delay operation for a while when the machine is switched on to prevent cool air circulation at the beginning. After switching on, air flow amount and temperature may be separately adjusted as desired.

## Automatic temperature control mode (ONLY WITH HEATER VERSION)

### Mode Selection (1)

Press "Mode" button to select Automatic temperature control mode.  
To set the temperature (heating) by button '+' and '-', 5 seconds later will be confirm;  
then to set the dehumidify by button '+' and '-', 5 seconds later will be confirm.

### Fan Selection (2)

Press "FAN" button to select the required amount of air flow, which is changed in the following sequence when pressed once:

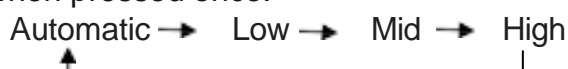
Automatic → Low → Mid → High  

#### NOTE:

- When Automatic FAN is selected, the unit will automatically select the suitable amount of air flow according to room temperature.

### Starting Operation (3)

Press " On/Off " button, and when the unit receives the signal, it gives out two " beep " tones,  
the operation light is on and the dehumidifier starts operation is automatic mode.

#### NOTE:

- In automatic temperature control mode, user can select the room temperature and humidity separately:

Heating (only w/heater version)	18~31°C adjustable	Factory setting is 25°C
Dehumidify	1%~99% adjustable	Factory setting is 60%

### Adjustment in Automatic mode

Feeling	Button	Operation
Unsuitable fan speed	FAN	Press once to change the air flow progressively until the suitable air flow is selected.

# Air Direction Adjustment

## Up-Down Air Direction Adjustment

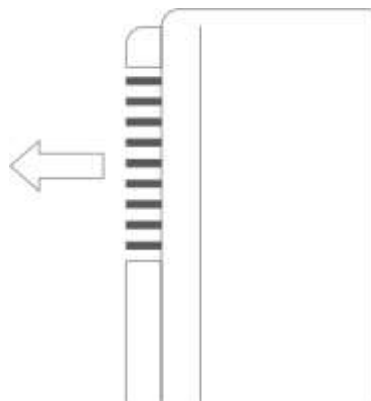

Airflow horizontally

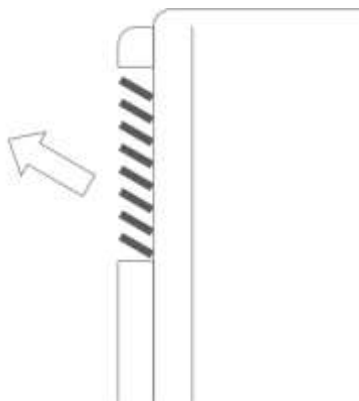

Airflow downward

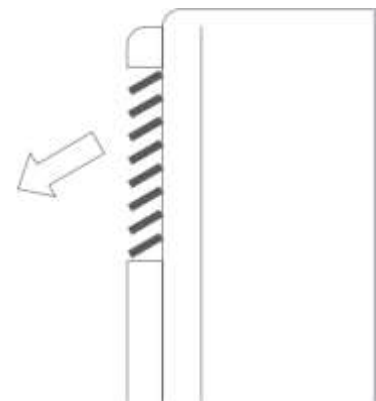

Airflow upward

**NOTE:**

- To stop the up-down air louver in a desired position, set the louver to automatic swinging and when it reaches the desired position, stop the louver from swinging.
- To get the best effect, the up-down air flow is usually set in the following manner: Dehumidifying - Horizontal air direction or upward air direction. Heating - Downward air direction.

## Changing Left-Right Air Direction

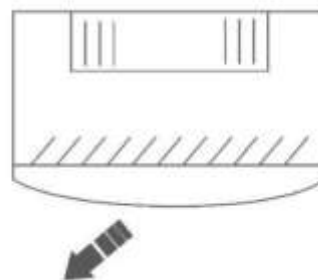
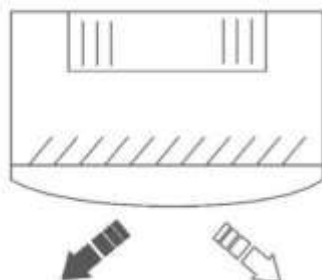
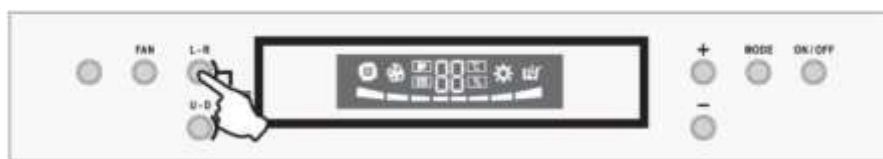

**NOTE:** Don't move the Left-Right vane directly.

## Timer Operations

### Timer Switch On

1. Press "L-R" and "U-D" button meanwhile for 5 seconds to set time for timer-on switching.

Press the button once to change the time interval of 1 hour in a cyclic manner of 4,5,6, ...12... 2,3,4. (The display is showing the previous time as the starting time of the present setting). If the button is held down, the time interval will increase progressively by 1 hour unit.

When the timer is set, is display a symbol .

#### NOTE:

- Usually, timer-on setting is made while the dehumidifier is not in operation. If timer-on is set while the dehumidifier is running, then the unit will shut down immediately and re-start at the pre-set time.
- If the "On-Off" button is pressed while the unit is under timer-on setting, then the unit will start immediately, the timer setting is cancelled and the timer light will be off.

### Timer Switch Off

1. Press "L-R" and "U-D" button meanwhile for 5 seconds to set time for timer-on switching.

Press the button once to change the time interval of 1 hour in a cyclic manner of 4,5,6, ...12... 2,3,4. (The display is showing the previous time as the starting time of the present setting). If the button is held down, the time interval will increase progressively by 1 hour unit.

When the timer is set, is display a symbol .

#### NOTE:

- Timer-Off can only be set when the Dehumidifier is running.
- Timer-On and Timer-Off cannot be set at the same time.
- If the "On-Off" button is pressed while the unit is under timer-off setting, then the unit will shut down immediately, the timer setting is cancelled and the timer light will be off.

### Timer Cancellation

- Press "L-R" and "U-D" button meanwhile for 5 seconds to cancel the timer-on or timer-off settings, at that time, symbol  disappears.



## Defrost system

### Sequences of the defrosting:

#### 1. Start

The defrosting is engaged if the following conditions are at the same time fulfilled:

- the compressor and the fan motor run without stopping;
- the defrosting sensor temperature lower than 3°C, and the duration of time more than 45min;
- the defrosting sensor temperature goes down to -7°C.

#### 2. After 15 seconds, the 4 way valve shifts.

3. 5 seconds after its stop, the compressor starts alone; And the accumulated freeze on the gills becomes melting, what is generally with a steam cloud.

#### 4. Stop:

The defrosting stops if one of the following conditions is fulfilled:

- the defrosting operates 20 seconds and the detected temperature by the defrost sensor goes up to 12°C;
- the compressor had run totally 8 minutes.

#### 5. The compressor runs.

#### 6. After 15 seconds the 4 way valve shifts

7. Five seconds after its stop the compressor and the fan start for restarting in heating mode.

8. The running light is blinking during defrosting.

## Water drainage system ( only for DEH-1700P )

During the dehumidify mode, the condenser water will be drained into the internal water tank .When the water reaches the certain level, the water drain pump will work. If the water can be drained out in 8 minutes, the dehumidifier will keep working. If not, the compressor and the motor will stop working. Mean while an error message “E4” will appear in the control panel to inform you to empty the water.

In this instance, you should cut the power off, and then restart the dehumidifier, and the operation will continue.

# Wiring diagram

For DEH-1200P

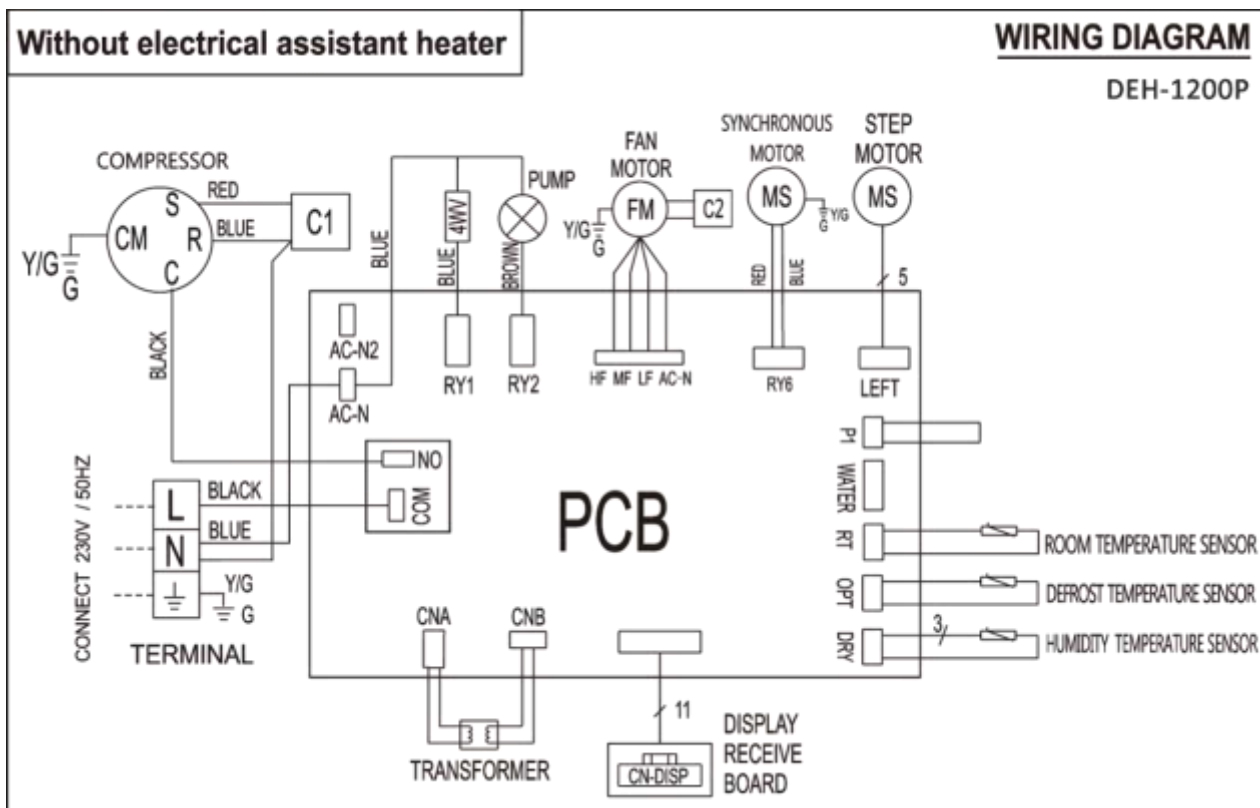



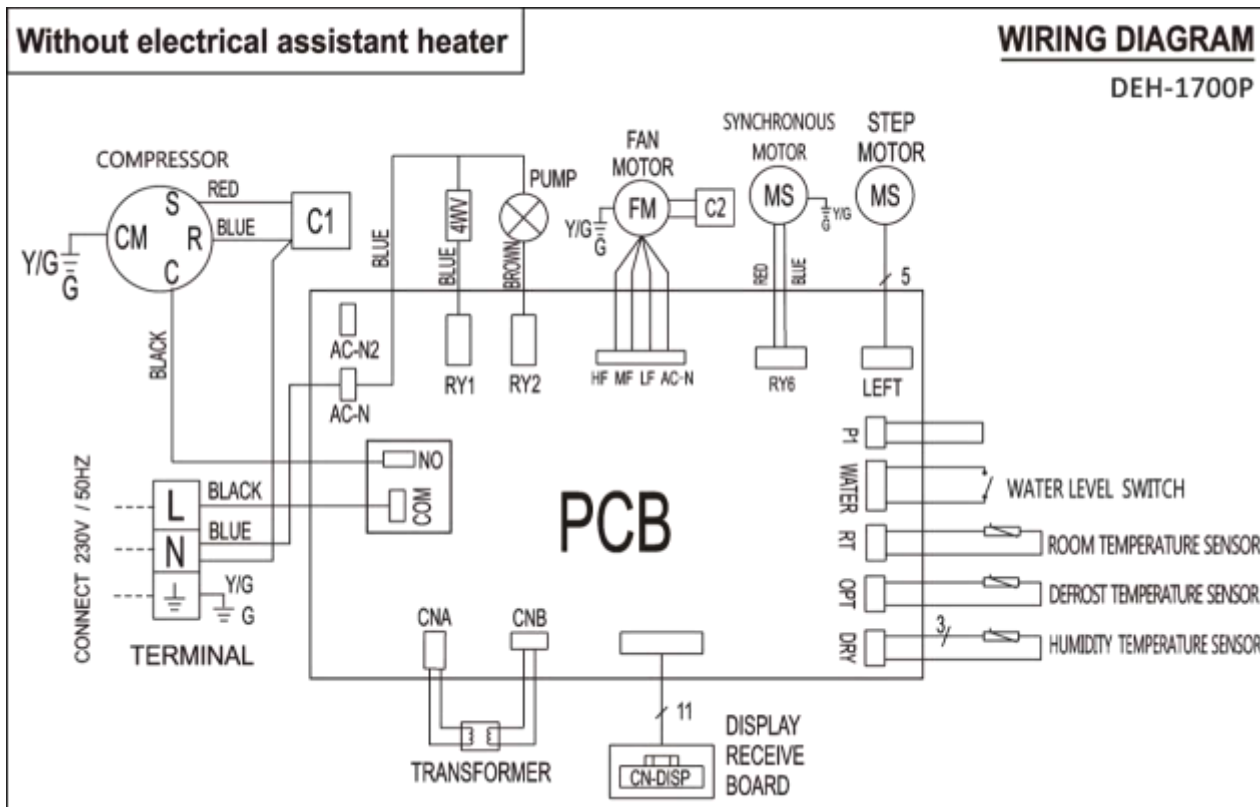



For DEH-1700P



## Maintenance

For smart use of the Dehumidifier:

<p>Setting of proper room temperature.</p> 	<p>Do not block the air inlet or outlet.</p> 	<p>Use the timer effectively.</p> 
<p>Close doors and windows during operation.</p> 	<p>If the unit is not to be used for a long time, turn off the power supply main switch.</p> 	<p>Use the louvers effectively.</p> 

## WARNING

Before maintenance, be sure to turn off the system and the circuit breaker.

### Body

Wipe the air conditioner by using a soft and dry cloth.  
For serious stains, use a neutral detergent diluted with water.  
Wring the water out of the cloth before wiping. then wipe off the detergent completely.



### Do not use the following for cleaning



Gasoline, benzine, thinner or cleanser may damage the coating of the unit.



Hot water over 40 °C (104°F ) may cause discoloring or deformation.

### Air Filter cleaning

Press the clasp on the top of the grill and pull the grill out, and  
Then the filter will be taken out along a gradient way.

### Clean the filter.

Use a vacuum cleaner to remove dust, or wash the filter with water.

After washing, dry the filter completely in the shade. Then, reinstall it onto the unit.



## To keep your Dehumidifier in good condition after season:

1. Operate in FAN mode for about half a day.

On a fine day, unit shall be started and operate in FAN mode for about half a day until the inside of the unit becomes thoroughly dry.

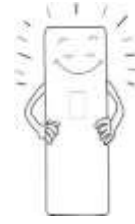

2. Turn off the power supply main switch.

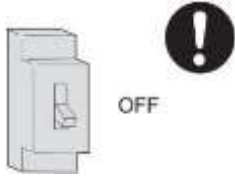

3. Cleaning the body.





## Error Codes



- E1: Room temperature sensor error;
- E2: Defrost temperature sensor error;
- E3: Humidity sensor error;
- E4: Drain error;
- P1: Electrical heater error;

## Trouble shooting

Before asking for service, check the following first.

	Phenomenon	Cause or check points
Normal Performance inspection	The system does not restart immediately. 	<ul style="list-style-type: none"> <li>● When unit is stopped, it won't restart immediately until 3 minutes have elapsed to protect the system.</li> <li>● When the electric plug is pulled out and reinserted, the protection circuit will work for 3 minutes to protect the dehumidifier.</li> </ul>
	Noise is heard: 	<ul style="list-style-type: none"> <li>● During unit operation or at stop, a swishing or gurgling noise may be heard. At first 2-3 minutes after unit start, this noise is more noticeable. (This noise is generated by refrigerant flowing in the system.)</li> <li>● During unit operation, a cracking noise may be heard. This noise is generated by the casing expanding or shrinking because of temperature changes.</li> <li>● Should there be a big noise from air flow in unit operation, air filter may be too dirty.</li> </ul>
	Smells are generated.	<ul style="list-style-type: none"> <li>● This is because the system circulates smells from the interior air such as the smell of furniture, cigarettes.</li> </ul>
Multiple check	Does not work at all.	<ul style="list-style-type: none"> <li>● Is power plug inserted?</li> <li>● Is there a power failure?</li> <li>● Is fuse blown out?</li> </ul>
	Inefficient	<ul style="list-style-type: none"> <li>● Is the air filter dirty? Normally it should be cleaned every 15 days.</li> <li>● Are there any obstacles before inlet and outlet? Is temperature set correctly?</li> <li>● Are there some doors or windows left open?</li> </ul>

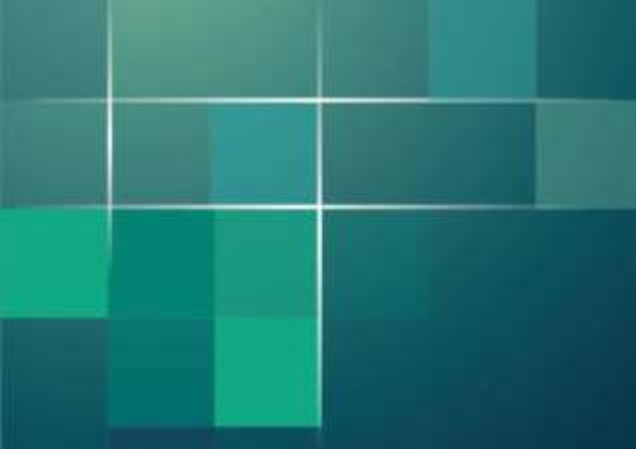

[www.danvex.com](http://www.danvex.com)

